



ULTRA QUIET & OIL FREE

AIR COMPRESSOR

OWNER'S MANUAL

1610A

1675A

1650A

3010

4620A

4610A

4610

6310

TABLE OF CONTENTS

INTRODUCTION _____	2
IMPORTANT SAFETY INSTRUCTIONS _____	3
LOCATIONS OF IMPORTANT LABELS _____	6
AIR COMPRESSOR COMPONENTS _____	9
PRE-OPERATION CHECKLIST _____	14
Package Contents & Assembly _____	14
Inspect for Damage _____	15
Save Packaging _____	15
Compressor Location _____	15
Electrical Power _____	16
OPERATING THE AIR COMPRESSOR _____	16
Introduction _____	16
Assembly _____	16
Test Run & Break-in Period _____	17
Daily Operation _____	17
MAINTENANCE _____	18
Draining the Air Tank _____	18
Changing the Air Filter _____	18
Testing for Leaks _____	18
Adjusting the Pressure Switch _____	18
Cleaning _____	18
STORAGE _____	18
TROUBLESHOOTING _____	19
SPECIFICATIONS _____	20
Electrical Circuit _____	20
Air Passage Drawing _____	20
WARRANTY _____	21
PRODUCT REGISTRATION _____	23

INTRODUCTION

! WARNING

This manual contains important instructions for operating this product. For your safety, and the safety of others, be sure to read this manual thoroughly before operating the product.

Failure to properly follow all the instructions and precautions can cause you and others to be seriously hurt or killed.

Thank you for purchasing a California Air Tools, Inc. Air Compressor.

Record the model and serial numbers indicated on your air compressor's nameplate:

Model No. _____

Serial No. _____

Date of Purchase: _____

Store/Dealer: _____

Model: 4620A
4610A
4610

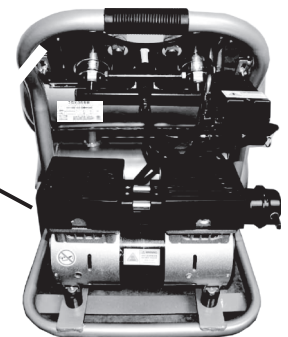
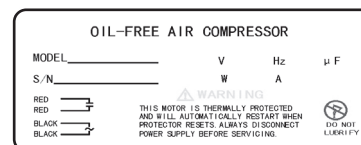

Model: 1610A, 1675A, 1650A



Model: 6310



How to find a local service center:

Even quality built equipment might need service or repair parts. Contact the California Air Tools Customer Service Department:

Phone: 1-866-409-4581

Online: WWW.CALIFORNIAAIRTOOLS.COM

Please provide the information below:

- n Model number and Serial number and specifications shown on the Model number/Serial number plate.
- n Part number or numbers shown in the parts list section of the owner's manual for your air compressor model.
- n A brief description of the trouble with the air compressor.

Do not return your air compressor for service or parts to the store/dealer where purchased .

IMPORTANT SAFETY INSTRUCTIONS

Safety Messages & Signal Words:

⚠ DANGER

Indicates an immediate hazardous situation which, if not avoided, will result in death or serious injury to the operator or to bystanders.

⚠ WARNING

Indicates a potentially hazardous situation which, if not avoided, could result in death or serious injury to the operator or to bystanders.

⚠ CAUTION

Indicates a potentially hazardous situation which, if not avoided, may result in moderate or minor injury to the operator or to bystanders.

NOTICE

Indicates a situation which, if not avoided, may result in damage to product components or other property.

⚠ DANGER



KICKBACK

Moving parts can cause severe trauma.

Keep hands and feet away from rotating parts, tie up long hair, remove jewelry, and DO NOT wear loose clothing.

⚠ DANGER



SHOCK

There is a danger of electric shock.

Use only undamaged electrical cords.

DO NOT touch bare wires or receptacles.

DO NOT operate air compressor in wet weather or in wet conditions.

DO NOT touch air compressor or cords if hands or feet are wet.

Ensure that all cords are free of damage before connecting to the power supply.

Ensure that you have a sufficient electrical supply for supporting the requirements of the motor.

⚠ WARNING



RISK TO BREATHING

Dust or dust-like particulates caused by power-sanding, sawing, grinding, drilling or any other construction-like activities can contain contaminants that are harmful to breathe.

Always use your air compressor in a well-ventilated and clean area.

Never breathe the air that comes directly out of the air compressor or air hose. This air is not suitable for breathing.

Always wear approved safety equipment. When performing dust-creating activities, securely wear properly-fit face masks or respirators.

If you feel ill from breathing while operating your air compressor, stop and seek medical attention immediately.

⚠ WARNING



FLYING OBJECTS

Flying objects can cause injury to the eyes, head and other parts of the body.

Air-powered equipment and power tools are capable of propelling items (metal chips, fasteners and particulates) at high speed into the air and could result in injury.

Always wear approved head and eye protection.

Never point the air stream at any part of your body, or at another person or animal.

When operating the air compressor, make sure all other people and animals maintain a safe distance.

Do not move the air compressor when the air tank is under pressure.

Never use the air hoses to pull or move the air compressor.

Keep the air compressor on a flat surface.

⚠ WARNING



HOT SURFACE



FIRE

Air compressor surfaces become hot during operation.

DO NOT touch hot surfaces, because they can cause severe burns.

Do not touch the air compressor's cylinder head. During operation, the cooling fins of the cylinder head and delivery pipe become hot.

Allow the air compressor to cool before touching it.

DO NOT place a storage cover on the unit during operation. Only place a cover on the air compressor after it has thoroughly cooled down.

⚠ WARNING



EXPLOSION

Exercise caution when using pressurized air.

To prevent injury and for your general safety, only use high-pressure hoses, fittings and couplings designed for use with air compressors.

Inspect all hoses, fittings and couplings for leaks and wear. When leaks and wear are detected, stop use and replace those items immediately. Do not repair.

Never leave pressurized air in the air tank when performing maintenance.

Never leave the air compressor unattended with the power supply in use and the air hose connected.

⚠ WARNING



EXPLOSION

Improper care could lead to the air tank bursting or exploding.

Drain air tank daily or after each use to prevent moisture buildup in the air tank.

Rust can weaken the air tank and cause leaks or bursting. If rust is detected, replace tank immediately. Do not try to repair the air tank by welding, drilling or modifying it in any other way. These modifications can weaken the air tank and cause a hazardous condition.

If air tank develops a leak, replace the air tank immediately. Never repair, weld or make modifications to the air tank or its attachments.

Never make adjustments to the factory-set pressures.

Never exceed manufacturer's maximum-allowable pressure rating attachments.

Because of extreme heat, do not use plastic pipe or lead tin solder joints for a discharge line.

⚠ WARNING



EXPLOSION



FIRE

Use caution to minimize risk of fire or explosion.

It is normal for the air compressor motor and pressure switch to produce sparks while operating. If sparks come in contact with vapors from gasoline or solvents, they may ignite and cause a fire or explosion.

Abrasive tools such as grinders, drills and other tools are capable of making sparks that can ignite flammable materials.

Always operate the air compressor a safe distance away from flammable items. Use in well-ventilated areas.

Never exceed the maximum rated pressure.

⚠ CAUTION

Use caution when using extension cords.

Use an extension cord which is no more than 25 feet long and at least 14 gauge.

Using an excessively long or thin-wired extension cord will cause severe damage to the motor.

Use only a 3-wire extension cord that has a 3-blade grounding plug.

LOCATIONS OF IMPORTANT LABELS

Read these important labels before operating.

These labels provide important safety and maintenance information. These labels should be considered as permanent parts of the air compressor. Should any of these labels become illegible, damaged or removed, please contact California Air Tools Customer Service department at 1-866-409-4581 for replacements.

Model: 4620A / 4610A / 4610

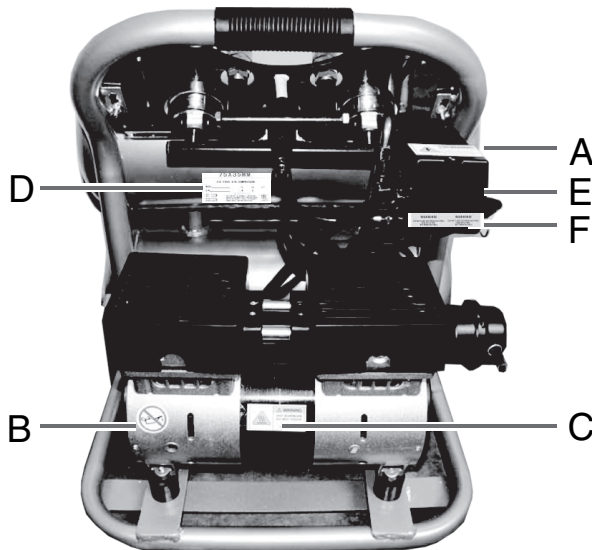





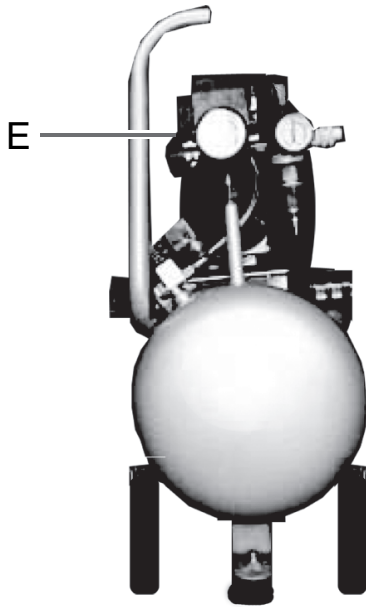
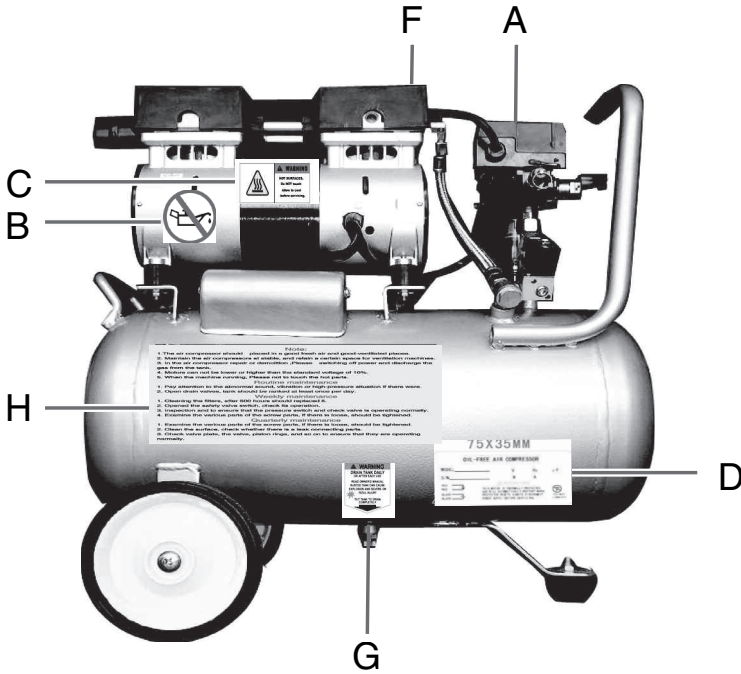

PRODUCT LABEL	
A	
B	
C	
D	
E	
F	
G	
H	<p>Note:</p> <ol style="list-style-type: none"> The air compressor should only be placed in a well-ventilated and clean area. Keep the air compressor on a firm and flat surface, with adequate space surrounding it for ventilation. If the air compressor needs repair or becomes damaged, turn off the power and drain the tank. Motors cannot be more than 10% lower or higher than the standard voltage. When the compressor is running, do not touch its hot surfaces. <p>Routine maintenance</p> <ol style="list-style-type: none"> Always listen for unusual sounds, vibrations or high-pitched noises. Open the drain valves to empty the air tank at least once per day. <p>Weekly maintenance</p> <ol style="list-style-type: none"> Clean the air filter weekly. Replace it with a new one after 500 hours of use. Open the safety valve to ensure that it is operational. Ensure that the pressure switch and check valve are operating normally. Inspect all screws and connections, and tighten if any are loose. <p>Quarterly maintenance</p> <ol style="list-style-type: none"> Inspect all screws and connections, and tighten if any are loose. Clean the compressor's exterior, and check for leaky connections. Check the valve plate, valve, piston rings, etc., to ensure that they are operating normally.

AIR COMPRESSOR

Model: 6310



PRODUCT LABEL	
A	 <p>WARNING DO NOT ADJUST FACTORY SETTINGS. TO REDUCE RISK OF ELECTRICAL SHOCK DO NOT REMOVE COVER. PRESSURE CONTROLS SET AT FACTORY FOR MAXIMUM SAFE OPERATION.</p>
B	
C	 <p>WARNING HOT SURFACES. Do NOT touch Allow to cool before servicing.</p>
D	<p>OIL-FREE AIR COMPRESSOR</p> <p>MODEL _____ V _____ Hz _____ μF S/N _____ W _____ A</p> <p>WARNING THIS MOTOR IS THERMALLY PROTECTED AND WILL AUTOMATICALLY RESTART WHEN PROTECTOR RESETS. ALWAYS DISCONNECT POWER SUPPLY BEFORE SERVICING.</p> <p>RED  BLACK  BLACK </p> <p>DO NOT LUBRIFY</p>
E	<p>USE SWITCH TO START AND STOP COMPRESSOR</p>
F	<p>WARNING! DO NOT USE EXTENSION CORD. USE AIR HOSE EXTENSION ONLY.</p> <p>WARNING! DO NOT USE EXTENSION CORD. USE AIR HOSE EXTENSION ONLY.</p>
G	<p>WARNING DRAIN TANK DAILY OR AFTER EACH USE READ OWNER'S MANUAL RUSTED TANK CAN CAUSE EXPLOSION AND SEVERE OR FATAL INJURY TILT TANK TO DRAIN COMPLETELY</p>
H	<p>Note:</p> <ol style="list-style-type: none"> The air compressor should only be placed in a well-ventilated and clean area. Keep the air compressor on a firm and flat surface, with adequate space surrounding it for ventilation. If the air compressor needs repair or becomes damaged, turn off the power and drain the tank. Motors cannot be more than 10% lower or higher than the standard voltage. When the compressor is running, do not touch its hot surfaces. <p>Routine maintenance</p> <ol style="list-style-type: none"> Always listen for unusual sounds, vibrations or high-pitched noises. Open the drain valves to empty the air tank at least once per day. <p>Weekly maintenance</p> <ol style="list-style-type: none"> Clean the air filter weekly. Replace it with a new one after 500 hours of use. Open the safety valve to ensure that it is operational. Ensure that the pressure switch and check valve are operating normally. Inspect all screws and connections, and tighten if any are loose. <p>Quarterly maintenance</p> <ol style="list-style-type: none"> Inspect all screws and connections, and tighten if any are loose. Clean the compressor's exterior, and check for leaky connections. Check the valve plate, valve, piston rings, etc., to ensure that they are operating normally.





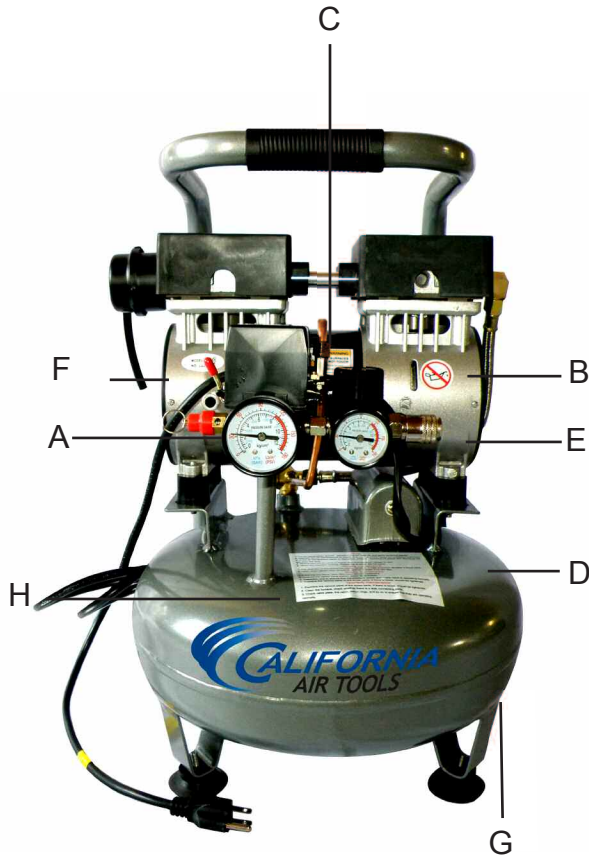

AIR COMPRESSOR

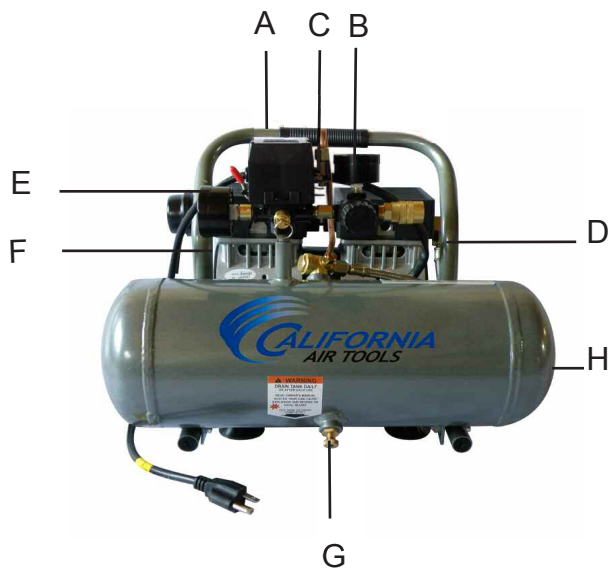
Model: 3010

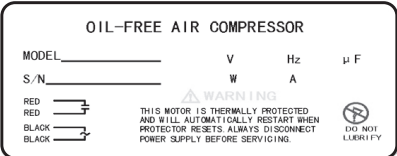

Model: 1610A, 1675A, 1650A



PRODUCT LABEL	
A	 <p>WARNING DO NOT ADJUST FACTORY SETTINGS. TO REDUCE RISK OF ELECTRICAL SHOCK DO NOT REMOVE COVER. PRESSURE CONTROLS SET AT FACTORY FOR MAXIMUM SAFE OPERATION.</p>
B	
C	 <p>WARNING HOT SURFACES. Do NOT touch. Allow to cool before servicing.</p>
D	 <p>OIL-FREE AIR COMPRESSOR MODEL _____ V _____ Hz _____ μF S/N _____ W _____ A RED → THIS MOTOR IS THERMALLY PROTECTED AND WILL AUTOMATICALLY RESTART WHEN PROTECTOR RESETS. ALWAYS DISCONNECT POWER SUPPLY BEFORE SERVICING. BLACK → DO NOT LUBRICATE</p>
E	 <p>USE SWITCH TO START AND STOP COMPRESSOR</p>
F	 <p>WARNING! DO NOT USE EXTENSION CORD. USE AIR HOSE EXTENSION ONLY. WARNING! DO NOT USE EXTENSION CORD. USE AIR HOSE EXTENSION ONLY.</p>
G	 <p>WARNING DRAIN TANK DAILY OR AFTER EACH USE READ OWNER'S MANUAL RUSTED TANK CAN CAUSE EXPLOSION AND SEVERE OR FATAL INJURY TILT TANK TO DRAIN COMPLETELY</p>
H	<p>Note:</p> <ol style="list-style-type: none"> The air compressor should only be placed in a well-ventilated and clean area. Keep the air compressor on a firm and flat surface, with adequate space surrounding it for ventilation. If the air compressor needs repair or becomes damaged, turn off the power and drain the tank. Motors cannot be more than 10% lower or higher than the standard voltage. When the compressor is running, do not touch its hot surfaces. <p>Routine maintenance</p> <ol style="list-style-type: none"> Always listen for unusual sounds, vibrations or high-pitched noises. Open the drain valves to empty the air tank at least once per day. <p>Weekly maintenance</p> <ol style="list-style-type: none"> Clean the air filter weekly. Replace it with a new one after 500 hours of use. Open the safety valve to ensure that it is operational. Ensure that the pressure switch and check valve are operating normally. Inspect all screws and connections, and tighten if any are loose. <p>Quarterly maintenance</p> <ol style="list-style-type: none"> Inspect all screws and connections, and tighten if any are loose. Clean the compressor's exterior, and check for leaky connections. Check the valve plate, valve, piston rings, etc., to ensure that they are operating normally.

AIR COMPRESSOR COMPONENTS

Model: 4610A

4610

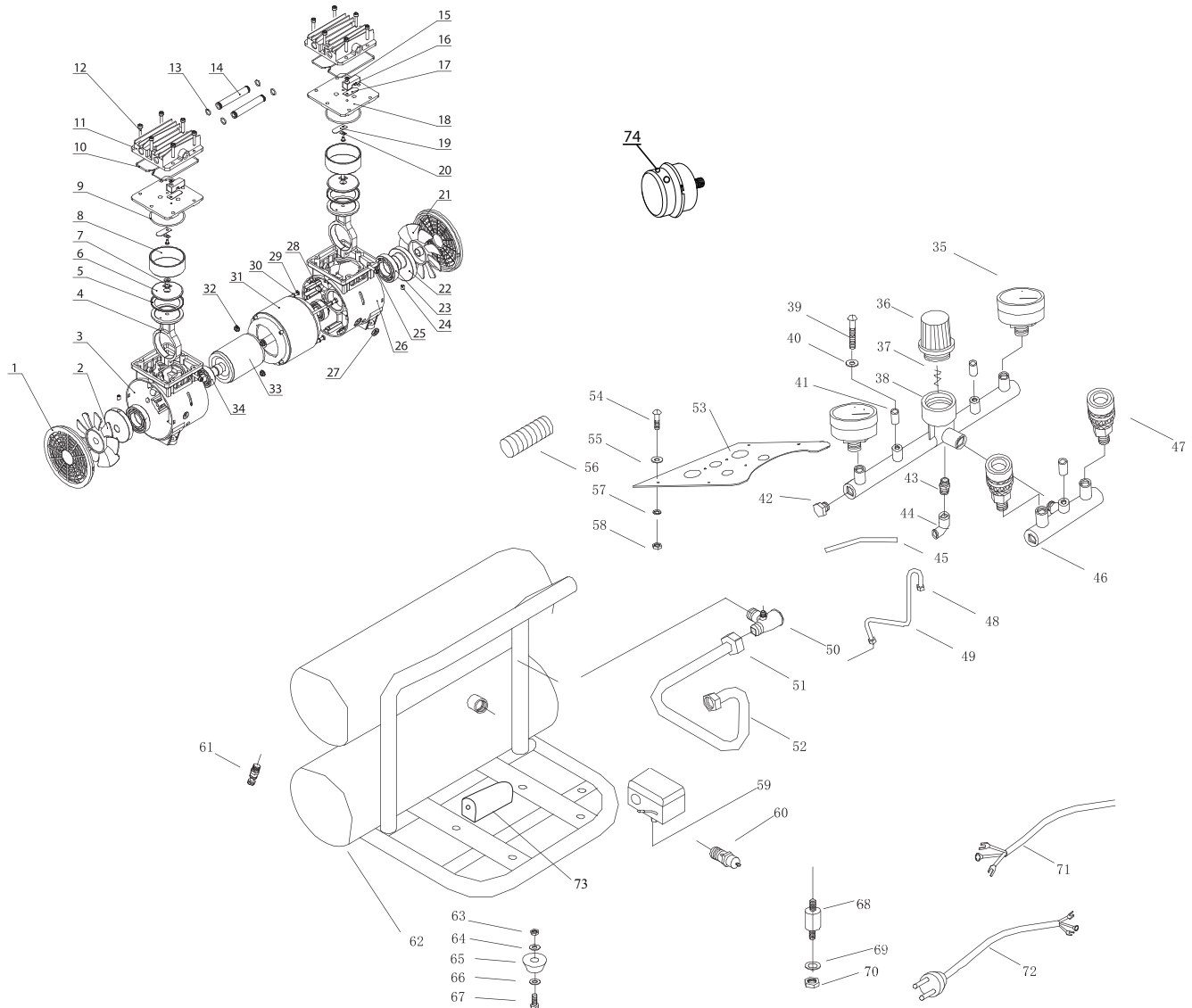

NO.	Description	NO.	Description	NO.	Description	NO.	Description
1	Fan Cover	20	Metal Strengthen Sheet	39	Bolt	58	Nut
2	Fan	21	Fan	40	Washer	59	Pressure Switch
3	Crank Case	22	Crank	41	Joint	60	Safety Valve
4	Connecting Rod	23	Bearing	42	Bolt	61	Drain Valve
5	Piston Ring	24	Holding Screw	43	Connecting Bar	62	Tank
6	Plate Pinch	25	Cheese Head Screw	44	Elbow Exhaust	63	Nut
7	Pressure Plate Screw	26	Crank Case	45	Pipe	64	Washer
8	Cylinder	27	Leading-out Line Guard Circle	46	Support II	65	Cushion Foot
9	Cylinder Obturating Ring	28	Rotor Pin	47	1/4" Quick Connect	66	Washer
10	Cylinder Head Obturating Ring	29	Motor Screw	48	Unloading Nut	67	Bolt
11	Cylinder Head	30	Spring Washer	49	Unloading Pipe	68	Foot
12	Cylinder Head Screw	31	Stator	50	Check Valve	69	Washer
13	Connecting Hose Obturating Ring	32	Lock Nut	51	Exhaust Nut	70	Nut
14	Connecting Hose	33	Rotor	52	Exhaust Pipe	71	Electrical Wire
15	Pan Head Screw	34	Bearing	53	Panel	72	Power Cord with Plug
16	Limited Block	35	Pressure Gauge	54	Bolt	73	Capacitor
17	Gassing Valve Plate	36	Regulator	55	Washer	74	Air Filter
18	Valve Plate	37	Spring	56	Handle		
19	Air Inflow Valve Plate	38	Support 1	57	Spring		

AIR COMPRESSOR

Model: 6310

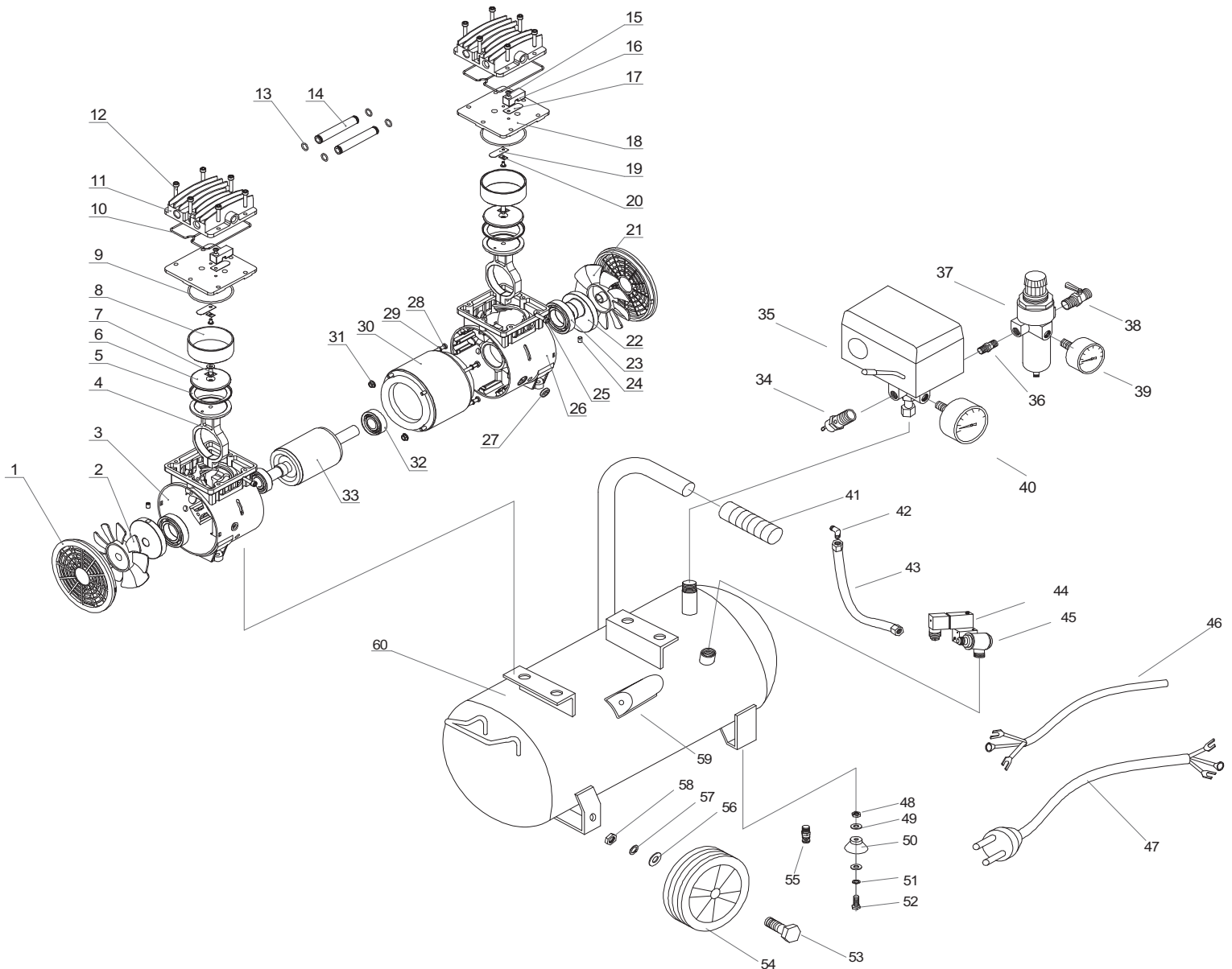

NO.	Description	NO.	Description	NO.	Description
1	Fan Cover	21	Fan	41	Handle Cover
2	Fan	22	Crank	42	Elbow
3	Crank Case	23	Bearing	43	Exhaust Pipe
4	Connecting Rod	24	Holding Screw	44	Electromagnetism Valve
5	Piston Ring	25	Cheese Head Screw	45	Check Valve
6	Plate Pinch	26	Crank Case	46	Electrical Wire
7	Pressure Plate Screw	27	Leading-out Line Guard Circle	47	Power Cord with Plug
8	Cylinder	28	Motor Screw	48	Nut
9	Cylinder Obturating Ring	29	Spring Washer	49	Washer
10	Cylinder Head Obturating Ring	30	Stator	50	Cushion Foot
11	Cylinder Head	31	Lock Nut	51	Washer
12	Cylinder Head Screw	32	Bearing	52	Bolt
13	Connecting Hose Obturating Ring	33	Rotor	53	Bolt
14	Connecting Hose	34	Safety Valve	54	Wheel
15	Pan Head Screw	35	Pressure Switch	55	Drain Valve
16	Limited Block	36	Connecting Bar	56	Washer
17	Gassing Valve Plate	37	Regulator	57	Spring Washer
18	Valve Plate	38	1/4" Quick Connect Coupler	58	Nut
19	Air Inflow Valve Plate	39	2" Pressure Gauge	59	Capacitor
20	Metal Strengthen Sheet	40	2.5" Pressure Gauge	60	Air Tank

AIR COMPRESSOR

Model: 4620A

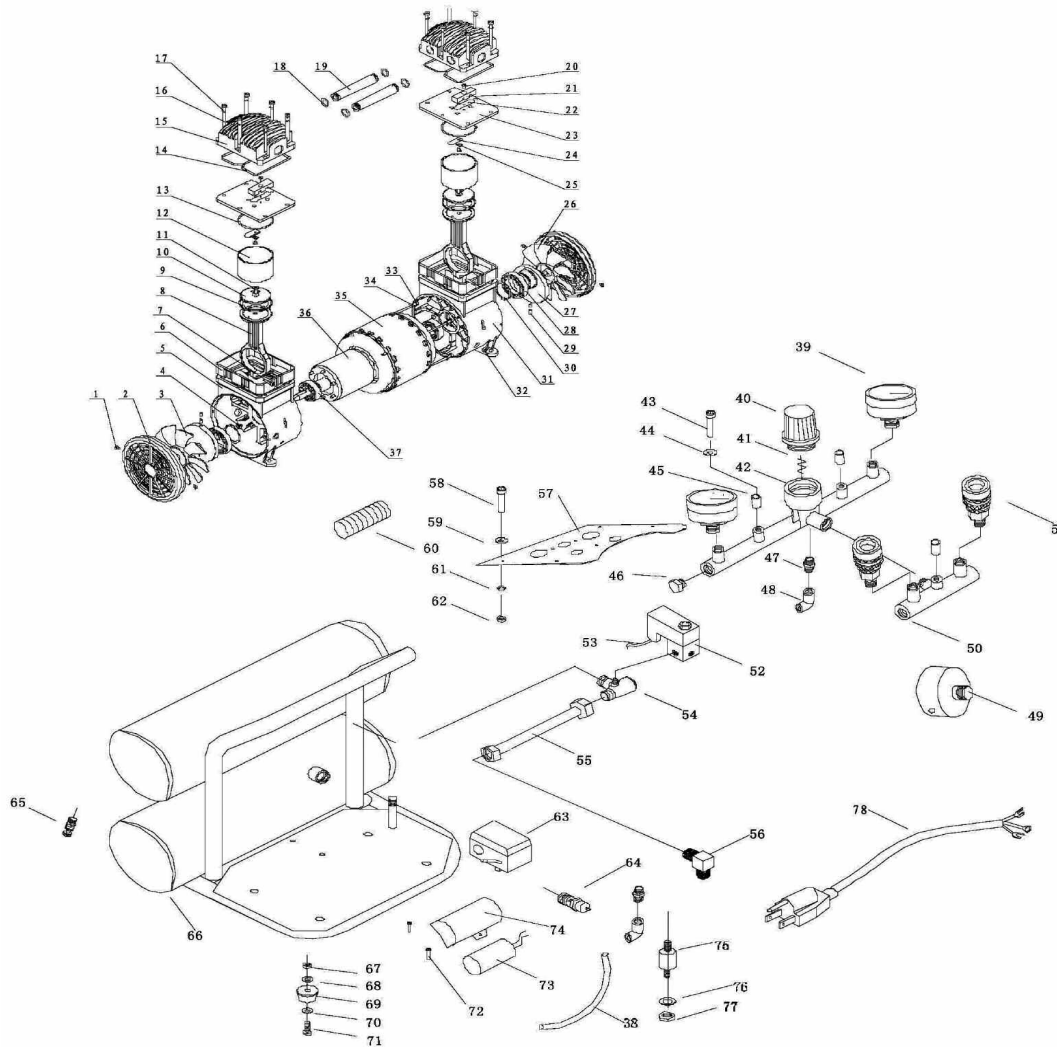

NO.	Description	NO.	Description	NO.	Description	NO.	Description
1	Bolt	21	Limited Block	41	Spring	61	Spring
2	Fan Cover	22	Gassing Valve Plate	42	Support I	62	Nut
3	Fan	23	Valve Plate	43	Bolt	63	Pressure Switch
4	Nut	24	Air Inflow Valve Plate	44	Washer	64	Safety Valve
5	Crank Case	25	Metal Strengthen Sheet	45	Joint	65	Drain Valve
6	Adjustment Stent	26	Fan	46	Bolt	66	Tank
7	Bolt	27	Crank	47	Connecting Bar	67	Nut
8	Connecting Rod	28	Bearing	48	Elbow Exhaust	68	Washer
9	Piston Ring	29	Holding Screw	49	Air Filter	69	Cushion Foot
10	Plate Pinch	30	Cheese Head Screw	50	Support II	70	Washer
11	Pressure Plate Screw	31	Crank Case	51	1/4" Quick Connect	71	Bolt
12	Cylinder	32	Leading-out Line Guard Circle	52	Electromagnetism	72	Bolt
13	Cylinder Obturating Ring	33	Motor Screw	53	Connecting Cord	73	Capacitor
14	Cylinder Head Obturating Ring	34	Spring Washer	54	Check Valve	74	Capacitor Cover
15	Cylinder Head	35	Stator	55	Exhaust Pipe	75	Foot
16	Cylinder Head Screw	36	Rotor	56	Elbow	76	Washer
17	Spring Washer	37	Bearing	57	Panel	77	Nut
18	Connecting Hose Obturating	38	PU Tube	58	Bolt	78	Power Cord with Plug
19	Connecting Hose	39	Pressure Gauge	59	Washer		
20	Pan Head Screw	40	Regulator	60	Handle		

AIR COMPRESSOR

Model: 1650A

1675A

1610A

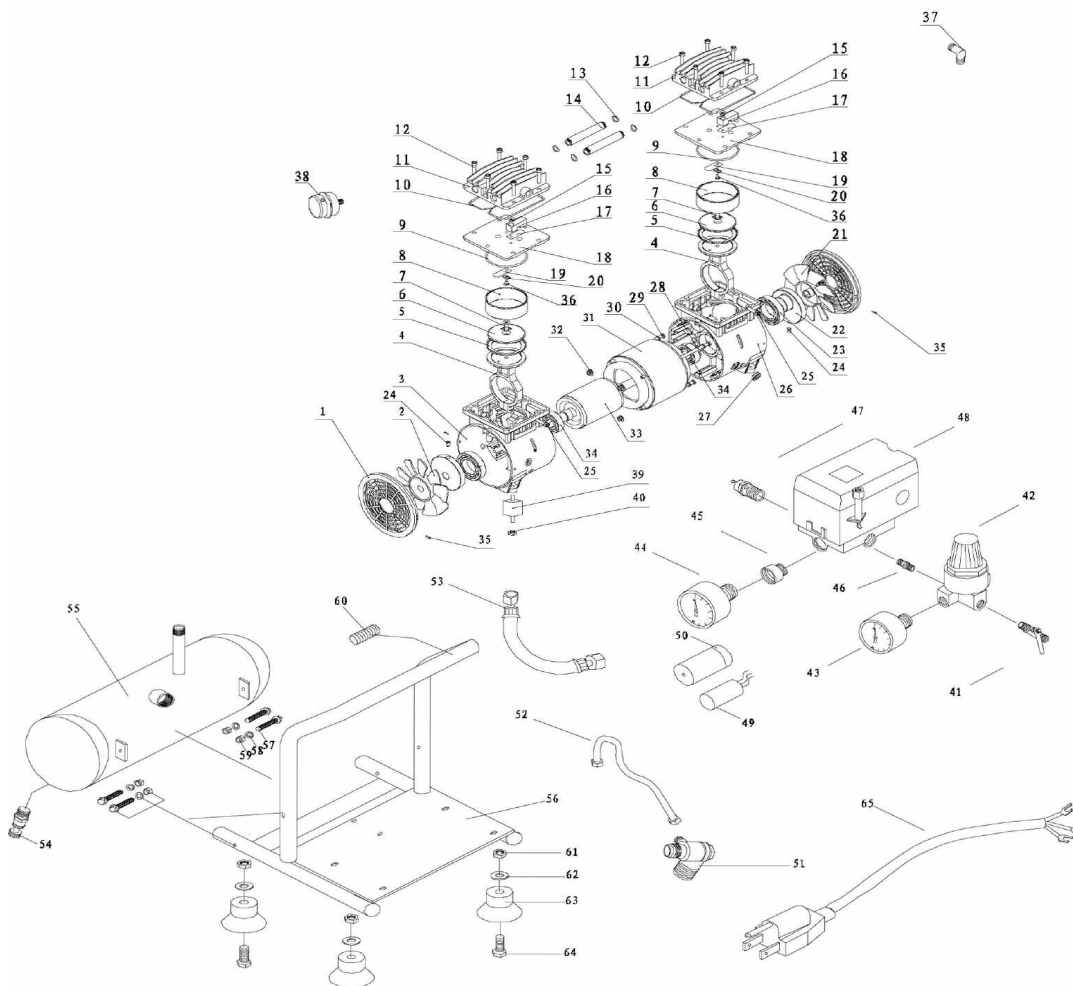

NO.	Description	NO.	Description	NO.	Description	NO.	Description
1	Fan Cover	20	Metal Strengthen Sheet	39	Shock Strut	58	Washer
2	Fan	21	Fan	40	Nut	59	Nut
3	Crank Case	22	Crank	41	1/4" Quick Connect	60	Handle Cover
4	Connecting Rod	23	Bearing	42	Regulator	61	Nut
5	Piston Ring	24	Holding Screw	43	Pressure Gauge/Small	62	Washer
6	Plate Pinch	25	Cheese Head Screw	44	Pressure Gauge/Large	63	Foot Cushion
7	Pressure Plate Screw	26	Crank Case	45	Pressure Gauge	64	Bolt
8	Cylinder	27	Leading-out Line Guard	46	Connecting Bar	65	Power Cord with Plug
9	Cylinder Obturating Ring	28	Rotor Pin	47	Safety Valve		
10	Cylinder Head Obturating Ring	29	Motor Screw	48	Pressure Switch		
11	Cylinder Head	30	Spring Washer	49	Capacitor		
12	Cylinder Head Screw	31	Stator	50	Capacitor Cover		
13	Connecting Hose Obturating	32	Lock Nut	51	Check Valve		
14	Connecting Hose	33	Rotor	52	Unloading Pipe		
15	Pan Head Screw	34	Bearing	53	Exhaust Pipe		
16	Limited Block	35	Bolt	54	Drain Valve		
17	Gassing Valve Plate	36	Bolt	55	Tank		
18	Valve Plate	37	Elbow Exhaust	56	Frame (1600)		
19	Air Inflow Valve Plate	38	Air Filter	57	Bolt		

PRE-OPERATION CHECKLIST

Package Contents & Assembly

Model:

4620A/4610A/4610/1610A/1675/1650A

Package contents:

- n Air Compressor
- n Owner's Manual
- n Air Filter (4620A (2) Air Filters)

Assembly:

- n Attach the air filter to the top right side of motor head.
Screw air filter into the motor head.
4620A - Attach the two air filters to the back top right and left of motor head, Screw air filters into motor head.

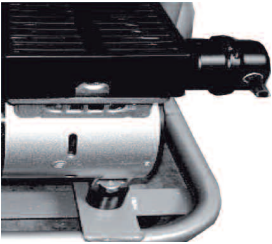

Model: 3010

Package contents:

- n Air Compressor
- n Owner's Manual
- n Air Filter

Assembly:

- n Attach the air filter to the top left side of motor head.
Screw air filter into the motor head



Model: 6310

Package contents:

- n Air Compressor
- n Owner's Manual
- n Air Filter
- n Wheel Assembly Kit

Assembly:

1. Bolt #53 (2)
 2. Wheel #54 (2)
 3. Washer #56 (2))
 4. Nut #58 (2)
- n Attach the air filter to the top rear side of the motor head.
Screw air filter into the motor head.



- n Install the wheel assembly as follows:
 1. Slide bolt #53 through wheel #54.
 2. Slide washer #56 onto the end of bolt #53.
 3. Slide the end of bolt #53 through the wheel support hole on the compressor.
 4. Attach nut #58 onto bolt #53 and tighten.
 5. Repeat steps 1-4 to assemble the other wheel.

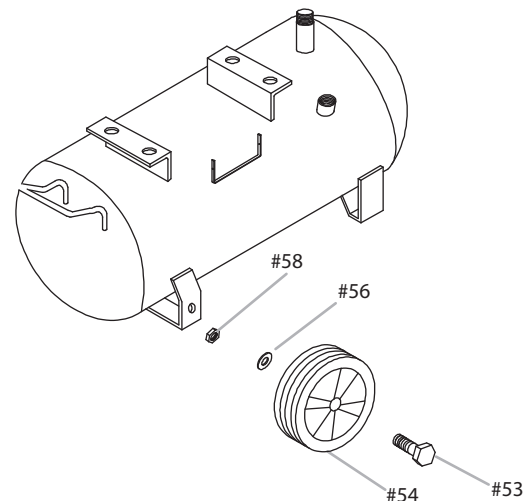

Inspect for Damage

Before using the air compressor, make sure the air tank is not damaged, inspect all parts for damage, and check that all pipes are firmly connected.

Do not use the air compressor if any damage is found. If damaged, have an authorized service center inspect and test the air compressor to ensure that is working properly.

Save Packaging

Save all outside packaging in case you ever need to return the product for service or repair.

Compressor Location

Use on Flat Surface

For proper operation, the air compressor must be placed on a flat surface with an incline no greater than 15 degrees.

! WARNING



EXPLOSION



FIRE

Use caution to minimize risk of fire or explosion.

It is normal for the air compressor motor and pressure switch to produce sparks while operating. If sparks come in contact with vapors from gasoline or solvents, they may ignite and cause a fire or explosion.

Abrasive tools such as grinders, drills and other tools are capable of making sparks that can ignite flammable materials.

Always operate the air compressor a safe distance away from flammable items. Use in well-ventilated areas.

Never exceed the maximum rated pressure.

Maintain a Clear Area

It is very important that the air compressor is positioned so that there is adequate airflow around the machine. There must be at least 2 feet of obstacle-free space surrounding and above the air compressor.

! WARNING



RISK TO BREATHING

Dust or dust-like particulates caused by power-sanding, sawing, grinding, drilling or any other construction-like activities can contain contaminants that are harmful to breathe.

Always use your air compressor in a well-ventilated and clean area.

Never breathe the air that comes directly out of the air compressor or air hose. This air is not suitable for breathing.

Always wear approved safety equipment. When performing dust-creating activities, securely wear properly-fit face masks or respirators.

If you feel ill from breathing while operating your air compressor, stop and seek medical attention immediately.

Use in Areas with Clean Air

For proper operation and to maximize the longevity of the air compressor, it is very important that the air drawn into the air compressor is clean. The air compressor should not be used in areas where dust or particulates are in the air. This will damage the motor and impair proper operation.

IMPORTANT: Always use the air filter, properly installed.

Electrical Power

Electrical Power Requirements

⚠ DANGER



SHOCK

There is a danger of electric shock.

Use only undamaged electrical cords.

DO NOT touch bare wires or receptacles.

DO NOT operate air compressor in wet weather or in wet conditions.

DO NOT touch air compressor or cords if hands or feet are wet.

Ensure that all cords are free of damage before connecting to the power supply.

Ensure that you have a sufficient electrical supply for supporting the requirements of the motor.

- n Before using the air compressor, refer to the serial label for voltage and amperage requirements. Make sure you have a sufficient electrical supply for supporting the motor's requirements.
- n Use a dedicated circuit for the best results.
- n Low voltage and/or an overload circuit can cause the motor's overload protection system circuit breaker to trip.

Electrical Extension Cords

⚠ CAUTION

Use caution when using extension cords.

Use an extension cord which is no more than 25 feet long and at least 14 gauge.

Using an excessively long or thin-wired extension cord will cause severe damage to the motor.

Use only a 3-wire extension cord that has a 3-blade grounding plug.

- n Inspect all electrical extension cords to ensure that they are free of damage.
- n When using an extension cord, use a heavy-duty cord that is no more than 25 feet long and at least 14 gauge.
- n Use only a 3-wire extension cord that has a 3-blade grounding plug.

OPERATING THE AIR COMPRESSOR

Save this manual for future reference.

⚠ WARNING

This manual contains important instructions for operating this product. For your safety, and the safety of others, be sure to read this manual thoroughly before operating the product.

Failure to properly follow all the instructions and precautions can cause you and others to be seriously hurt or killed.

Introduction

- n This air compressor features a compact structure, stable performance, a high airflow rate, and easy operation and maintenance. Because the air compressor produces no oil in the airflow, it can be used as an independent air supply machine for situations in which oil in the airflow is an issue.
- n The motor directly drives the eccentric wheel-connecting bar system, making the piston move reciprocally. The piston is made from a high-temperature-resistant and abrasion-resistant nonmetallic material, and is able to function without lubrication for a long time.
- n Compressed air discharges in the air tank. A pressure meter displays the pressure inside the tank. When the pressure inside the tank rises to 8 bar, the power is automatically cut off by the pressure-control switch. When the pressure inside the tank lowers to 6 bar, the power is turned back on by the pressure-control switch. This gradually raises the pressure in the air tank. This procedure happens repeatedly.

Assembly

1. Connect your air supply hose to the the quick-connect coupling.
2. Make sure the drainage valve is off and that the pressure switch is in the OFF position.
3. Ensure that the power supply you are going to use is operating normally.
4. Insert the power supply cord into the power supply socket.

Test Run

Before using the air compressor for the first time, complete a test run as follows:

1. Turn the power switch to the OFF position. Plug the power supply cord into a power supply socket. Start the air compressor by turning the power switch to the ON position. The pressure gauge reading will slowly rise as pressure increases inside the air tank. When the gauge reading reaches 120 PSI, the pressure switch will automatically turn the power off. This indicates that the compressor is working normally.
2. Turn the power switch to the Off position, unplug the power supply cord and release the air in the tank by pulling on the safety valve. At this point proceed to the next step (daily operations) starting the air compressor to continue to use.

Note: If the Air Compressor is not working properly, the pressure gauge will indicate that there is a decrease in pressure in the air tank. If there is an air leak from the compressor the pressure in the air tank decreases, the pressure switch resets and the motor automatically turns back on.

If you detect an air leakage, turn the power switch to the Off position, release the air from the tank by pulling on the safety valve. Unplug the power supply cord and contact Customer Support for Assistance.

! WARNING



FLYING OBJECTS

Flying objects can cause injury to the eyes, head and other parts of the body.

Air-powered equipment and power tools are capable of propelling items (metal chips, fasteners and particulates) at high speed into the air and could result in injury.

Always wear approved head and eye protection.

Never point the air stream at any part of your body, or at another person or animal.

When operating the air compressor, make sure all other people and animals maintain a safe distance.

Do not move the air compressor when the air tank is under pressure.

Never use the air hoses to pull or move the air compressor.

Keep the air compressor on a flat surface.

! WARNING



HOT SURFACE



FIRE

Air compressor surfaces become hot during operation.

DO NOT touch hot surfaces, because they can cause severe burns.

Do not touch the air compressor's cylinder head. During operation, the cooling fins of the cylinder head and delivery pipe become hot.

Allow the air compressor to cool before touching it.

DO NOT place a storage cover on the unit during operation. Only place a cover on the air compressor after it has thoroughly cooled down.

Daily Operation

Starting the compressor:

1. Turn the power switch to the OFF position.
2. Attach the air hose to the 1/4" quick connect coupler
3. Close the drainage valve.
4. Turn the regulator knob completely to the left.
This will turn down the pressure at the air hose before starting.
5. Plug the power supply cord into a power supply socket.
6. Turn the power switch to the ON position.
7. Let the motor run and tank fill until motor turns off.
8. Turn the regulator knob to the right increasing the pressure at the hose. Turn the pressure up until the desired pressure at the air hose is reached.
9. Operate air tool normally.
10. Only operate continuously for 1 hour maximum.
Allow compressor to cool down before restarting.

Shutting down the compressor:

1. Turn the power switch to the OFF position.
2. Unplug the power supply cord.
3. Reduce the pressure in the air tank through the air supply hose.

MAINTENANCE

Draining the Air Tank

The frequency at which you should drain the air tank depends on the environmental conditions and the amount of operating time logged. The average draining frequency is every 2 to 3 days.

1. Place the air compressor above a container capable of holding water.
2. With compressed air in the air tank, slowly turn the drain valve knob counterclockwise. The water in the air tank will drain out.
3. After all of the accumulated water has drained out, turn the drain valve knob clockwise until it is tight, in order to avoid leakage.

Changing the Air Filter

The air filter is designed to reduce noise and help prevent particulates in the air from entering and damaging the air compressor.

After being used for a period of time, the air filter will become clogged. This will reduce the air intake capabilities of the air compressor, reducing performance. Therefore, the air filter must be replaced regularly.

1. Open the lid on the air filter, then remove the old filter.
2. Replace it with a new filter, then close the lid.

Testing for Leaks

Make sure all connections are tight. Do not overtighten.

A small leak in any hose or pipe connection will reduce the air compressor's performance.

To test for small leaks, spray a small amount of soapy water on the area suspected of leaking. If the soap bubbles, replace the broken part.

Cleaning

Clean items with a soft brush, or wipe with a moistened cloth using a biodegradable solvent.

Do not use flammable liquids such as gasoline or alcohol. Always keep parts clean from dirt and dust for better performance.

Adjusting the Pressure Switch

The pressure switch is used to control the automatic stop-and-start function of the air compressor, ensuring the correct pressure of the compressed air in the air tank is maintained.

If the pressure of the compressed air in the air tank is found not to be in the standard range set by the manufacturer, the pressure switch must be adjusted to correctly set the activation valve. (The pressure at which the air compressor will stop running is 8 bar, and the pressure at which the air compressor will start running again is 6 bar.)

Adjust the pressure switch as follows:

1. Open the casing to access the pressure switch.
2. Adjust the setting screw for the maximum pressure. Turning the setting screw clockwise makes the activation pressure higher, so the pressure at which the air compressor stops running will be higher.
3. Adjust the setting screw for pressure difference. Turning the setting screw clockwise makes for a larger pressure difference, so the difference between the pressure at which the air compressor starts and the pressure at which the air compressor stops is larger.

Gradual adjustments should make the activation pressures within the range set by the manufacturer.

STORAGE

Before storing for a prolonged period of time:

1. Turn off the power supply.
2. Disconnect the power cord from the power supply.
3. Pull the relief valve and release all the pressure from the air tank.
4. Clean the air compressor to remove all dirt and dust.
5. Cover the air compressor with a cover to protect the unit from dust and moisture.
6. Do not stack or store any items on top of or around the air compressor. Damage could occur.

TROUBLESHOOTING

PROBLEM	POSSIBLE CAUSE	POSSIBLE SOLUTIONS
Pressure drop in the tank.	Air leaks at connections.	Let the compressor build pressure in the tank, to the maximum pressure if possible. Brush soapy water on air connections and look carefully for air bubbles. Tighten leaky connections. If the problem persists, contact the seller for further advice.
The solenoid valve leaks when the compressor is idle.	Non-return valve seal is defective.	Let the air in the tank flow out until all the pressure is released. Then remove the non-return valve plug and clean the valve seal. If necessary, replace the seal and then reinstall all components.
The compressor stopped and does not start.	Overload cutout operated because of motor overheating.	Check that the main voltage corresponds to specifications. An extension cord that is too thin or too long can cause a voltage drop and cause the motor to overheat. Allow the motor to cool down. Use heavy duty extension cords. Ensure that the compressor is plugged into a socket as close as possible to the consumer unit or fuse box.
	Motor windings are burned out.	Contact Customer Support.
The motor does not start and makes a humming noise.	Capacitor is burned out.	Replace starter capacitor.
The motor does not start or starts slowly.	Low voltage supply to the motor.	Check that the main voltage corresponds to specifications. An extension cord that is too thin or too long can cause a voltage drop and cause the motor to overheat. Allow the motor to cool down. Use heavy duty extension cords. Ensure that the compressor is plugged into a socket as close as possible to the consumer unit or fuse box.
The compressor is noisy with metallic clangs.	Compressor head gasket broken or valve faulty.	Stop the compressor and contact the dealer.
The compressor does not reach the maximum pressure.	Compressor head gasket broken or valve faulty.	Stop the compressor and contact the dealer.
The compressor doesn't seem to provide as much air as it did when new and/or the compressor cuts off within a much shorter time period.	The pressure switch needs adjusting.	Stop the compressor and contact the dealer.
	The tank is full of water due to condensation.	Open the ball valve and release the pressure. Open the drain valve and release the water within the tank.
The motor pump unit does not stop when the tank pressure reaches its maximum working pressure (8 bar or 116 PSI) and the safety valve vents air.	Pressure switch defective or needs adjusting.	Stop the compressor immediately and contact Customer Support.

SPECIFICATIONS

Electrical Circuit

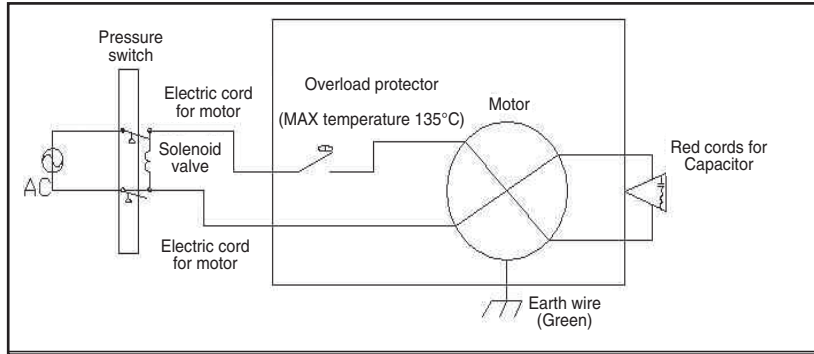

Air Passage Drawing

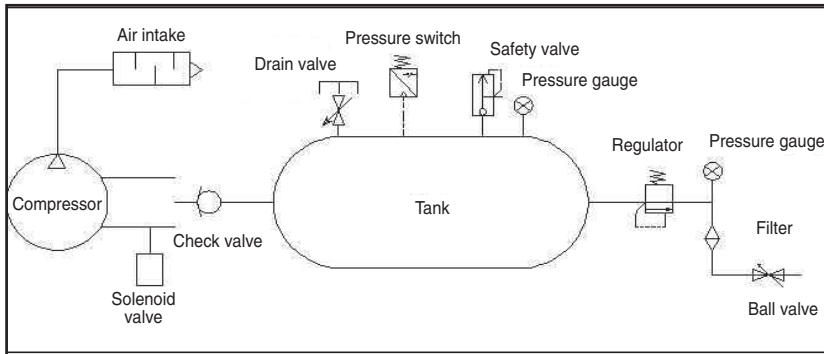

Air Compressor Model	4620A	4610 / 4610A	6310	3010	1610A	1675A	1650A
Output @ 40 PSI	7.00 CFM	3.80 CFM	3.80 CFM	3.80 CFM	3.80 CFM	2.40 CFM	1.90 CFM
Output @ 90 PSI	5.30 CFM	2.35 CFM	2.35 CFM	2.35 CFM	2.35 CFM	1.50 CFM	1.10 CFM
Maximum Pressure	125 PSI	120 PSI	120 PSI	120 PSI	120 PSI	120 PSI	120 PSI
Time to Fill Tank	60 Seconds	125 Seconds	130 Seconds	120 Seconds	50 Seconds	70 Seconds	90 Seconds
Motor							
Motor Type	Electric / 14.0 Amps	Electric / 7.6 Amps	Electric / 7.6 Amps	Electric / 7.6 Amps	Electric / 7.6 Amps	Electric / 5.5 Amps	Electric / 4.5 Amps
Horsepower	2.0 hp	1.0 hp	1.0 hp	1.0 hp	1.0 hp	3/4 hp	1/2 hp
Engine Speed	1680 RPM	1680 RPM	1680 RPM	1680 RPM	1680 RPM	1680 RPM	1680 RPM
Voltage / Hertz	110V / 60HZ	110V / 60HZ	110V / 60HZ	110V / 60HZ	110V / 60HZ	110V / 60HZ	110V / 60HZ
Features							
Pump	Oil-Free	Oil-Free	Oil-Free	Oil-Free	Oil-Free	Oil-Free	Oil-Free
Decibel Level	70 db	60 db	60 db	60 db	60 db	58 db	56 db
Tank Capacity	4.6 Gallons (18 Liters)	4.6 Gallons (18 Liters)	6.3 Gallons (24 Liters)	3.0 Gallons (11 Liters)	1.6 Gallons (6 Liters)	1.6 Gallons (6 Liters)	1.6 Gallons (6 Liters)
Tank Type	Aluminum	4610-Steel / 4610A-Al	Steel	Steel	Aluminum	Aluminum	Aluminum
Pressure Control Meter	2	2	2	2	2	2	2
Universal Quick Connectors	2	2	1	1	1	1	1
Thermal Overload Protector	Yes	Yes	Yes	Yes	Yes	Yes	Yes
Dimensions							
Length	19.3 inches (49.0 cm)	17.3 inches (43.9 cm)	23.6 inches (59.9 cm)	15.0 inches (38.1 cm)	17.3 inches (44.0 cm)	17.3 inches (44.0 cm)	17.3 inches (44.0 cm)
Width	16.9 inches (43.0 cm)	17.0 inches (43.2 cm)	13.3 inches (33.8 cm)	15.0 inches (38.1 cm)	14.2 inches (36.0 cm)	14.2 inches (36.0 cm)	14.2 inches (36.0 cm)
Height	19.6 inches (50.0 cm)	20.0 inches (50.8 cm)	24.0 inches (60.9 cm)	24.0 inches (60.1 cm)	14.6 inches (37.0 cm)	14.6 inches (37.0 cm)	14.6 inches (37.0 cm)
Weight	64 lbs (29.0 kg)	4610-53 lbs /4610A-44 lbs	49 lbs (22 kg)	46 lbs (21 kg)	35 lbs (15.9 kg)	34 lbs (15.4 kg)	31 lbs (14.0 kg)

CALIFORNIA AIR TOOLS INC. LIMITED WARRANTY

This warranty is limited to Air Compressors distributed by:

California Air Tools, Inc.
8560 Siempre Viva Road, Unit 3A
San Diego, CA 92154

Limited Warranty

California Air Tools Inc. will repair or replace, free of charge, to the original retail customer who purchased a California Air Tools, Inc. Air Compressor from an authorized dealer, distributor or distributor's dealer in North America.

This warranty does not transfer to subsequent owners.

California Air Tools Inc. will repair or replace, at its option, any parts of the portable air compressor that are proven by an authorized service center to be defective in material or workmanship under normal use during the applicable warranty time period as stated below. This limited warranty covers the cost of the replacement parts and labor for all defects when installed by an authorized service center. Transportation charges are the responsibility of the customer. Any part replaced under warranty becomes the property of California Air Tools Inc.

All parts replaced under warranty will be considered as part of original product, and any warranty on those parts will expire coincident with the original product warranty.

Limited Warranty Periods

Non-commercial / Non-rental (personal use by a retail customer):	1 year parts and labor
Commercial / Rental (usage for income, business use):	1 year parts and labor

The limited warranty period begins on the date of retail purchase by the original purchaser.

Disclaimers, Limitations of Remedies & Exclusions

This warranty gives you specific legal rights, and you may also have other rights which may vary from state to state.

Disclaimer of Other Warranties

To the fullest extent permitted by applicable law, this limited warranty is exclusive and expressly in lieu of any and all other warranties, including, without limitation, any implied warranties of merchantability or fitness for a particular purpose or any other implied warranties that may arise from the course of dealing or usage of the trade. California Air Tools Inc. hereby disclaims and excludes all other warranties. To the extent that California Air Tools Inc. products are consumer products under applicable federal and state law with respect to any customer, the duration of any implied warranties (including but not limited to implied warranties of merchantability or fitness for a particular purpose) are limited to the shortest duration permitted by applicable law or the Limited Warranty period provided herein, whichever is longer.

Limitations of Remedies

California Air Tools Inc. shall not be liable to customer, or anyone claiming under customer, for any other obligations or liabilities, including but not limited to, obligations or liabilities arising out of breach of contract or warranty, negligence or other tort or any theory of strict liability, with respect to the air compressor or California Air Tools Inc. acts or omissions or otherwise. To the fullest extent permitted by applicable law, California Air Tools Inc. shall not in any event be liable for incidental, compensatory, punitive, consequential, indirect, special or other damages, including but not limited to loss of use, loss of income, loss of time, loss of sales, injury to personal property, or liability customer incurs with respect to any other person, or any other type or form of consequential damage or economic loss.

Exclusions

In addition to the foregoing disclaimers, limitations and terms, this limited warranty shall not apply to and does not cover accessories, nor does it cover products that are in any way subject to any of the following:

1. Improper setup, installation or storage.
2. Lack of proper maintenance and service.
3. Accident, damage, abuse or misuse.
4. Abnormal operating conditions or applications.
5. Repair or modification by customer or any third party without written consent of California Air Tools Inc.
6. Use under operating conditions or in applications not recommended by California Air Tools Inc.
7. Normal wear.
8. The use of accessories or attachments not recommended by California Air Tools Inc.
9. Acts of God.

The application of these exclusions will be determined at the sole discretion of California Air Tools Inc.

Registration

Warranty registration with California Air Tools Inc. is required on all products.

You can mail the enclosed registration form.

Warranty is also available by keeping and showing your original receipt from the date of purchase to an Authorized California Air Tools Service Center.

Service

Do not return your air compressor to the place of purchase.

For all customer service inquiries call California Air Tools Customer Service at 1-866-409-4581 or visit

WWW.CALIFORNIAAIRTOOLS.COM

PRODUCT REGISTRATION

To register your product, please complete the information below and mail to the mailing address at the end of this page.

1. Personal Information:

Full Name (Include Middle Initial): _____

Mailing Address: _____

City: _____ State: _____ Zip Code: _____

Phone Number: _____

E-mail Address: _____

(Check here to receive product information and offers via e-mail)

(Check here to receive product information from other companies via e-mail)

2. Product Information:

Date of Purchase: _____ (MM / DD / YYYY)

Model Number: _____

Serial Number: _____ (Found on name plate)

Purchased Location: _____

Purchase Price: _____

Type of Primary Use for this Product: Home Recreation Emergency Rental Commercial
Other _____

Features Influencing Product Purchase: Brand Portability Power Rating Price Warranty
Other Features (describe) _____

What other Power Equipment are you interested in purchasing in the future? _____

Thank you for registering your product.

Mail to:
California Air Tools
8560 Siempre Viva Road, Unit 3A
San Diego, CA 92154